



## Fire-fighter lockers

### For storage of turn-out gear

Lista fire-fighter lockers are the perfect solution for the storage of turn-out gear used in the civil protection and work safety sectors. To ensure fast access, helmet holders are available for the housing cover or internal helmet compartments.



#### Good ventilation thanks to open design and ventilation slots in the base

The housing floor is equipped with additional ventilation slots on the inside and the front. The floor storage space provides enough room even for big boots.



#### Well-thought-out details

Belts are hooked on special coupling holders for easy and quick access.



#### Optional accessories

Different accessory parts allow the interior of the cabinets to be fitted out as required.

## i Benefits

- Locking, fitting, and housing specification options
- Fast access thanks to open design and sophisticated details
- Long useful lifetime thanks to use of high-quality materials

Lista fire-fighter lockers enable practical and quick storage of turn-out gear.



**Colours**

Cabinets in standard paint finish: flame red, RAL 3000.  
12 more standard colours available on request.

➤ For colour information see bookmark or fold-out



# Fire-fighter lockers

## Pre-configured cabinets

Shelves open or with solid sheet compartment doors



Art. no.  
**96.402.240**  
Flame red,  
RAL 3000

### i Features

- Key Lock locking system for shelves with doors or combination lock for individual configurations
- Standard paint finish: flame red, RAL 3000, durable powder coating; 12 more standard colours on request

### i Design diversity

- Compartment width 400 and 500 mm
- Housing depth 500 and 600 mm
- Cabinets with 1, 2 or 3 compartments
- Housing either standing on the floor and/or for placement on bases or for wall fastening (Bases and material for wall fastening not included)
- Choice of solid sheet doors for shelves, flush-fitting, mounted on the right, folded from one piece with pintle bearing assembly, flush with housing, opening angle approx. 110°
- Individual fitting options thanks to large range of accessories

**D** ↗ **500 mm**   **H** ↗ **1700 mm**   Housing cover with option of fastening helmet holders (not included in the price)

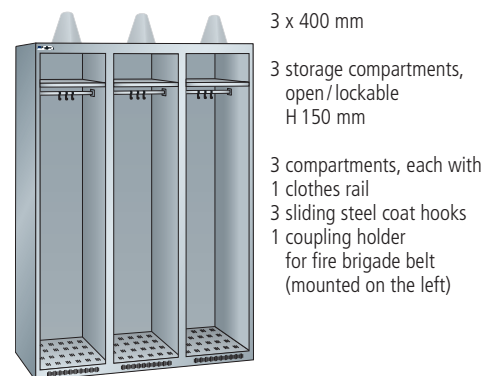
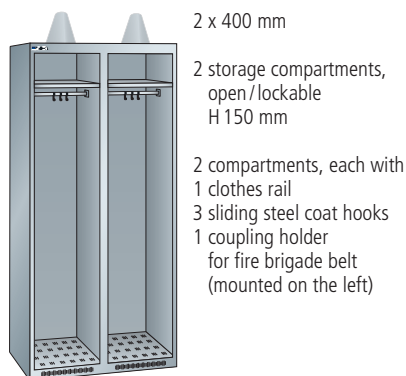
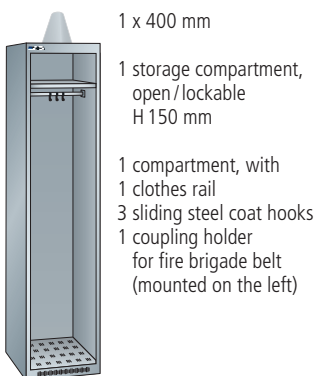

### Cabinets

#### Compartment: W 400 mm

Mounted helmet holders (not included in the price)



W → mm	Number of compartments	Compartment width mm	Storage compartment, open		Storage compartment, lockable with cylinder lock		
			Art. no.		Hinge pins mounted	Art. no.	
400	1	400	<b>96.454.240</b>		Pintle	<b>96.400.240</b>	
800	2	400	<b>96.455.240</b>		Pintle	<b>96.401.240</b>	
1200	3	400	<b>96.456.240</b>		Pintle	<b>96.402.240</b>	



**D** **500 mm** **H** **1700 mm** Housing cover with option of fastening helmet holders (not included in the price)

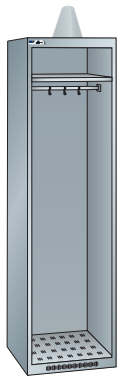

- 1 x 500 mm
- 1 storage compartment, open/lockable H 150 mm
- 1 compartment, with 1 clothes rail 3 sliding steel coat hooks 1 coupling holder for fire brigade belt (mounted on the left)

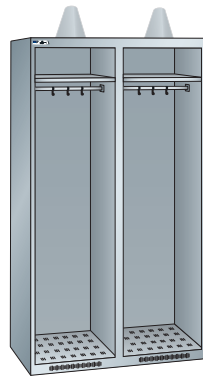

- 2 x 500 mm
- 2 shelves open/lockable H 150 mm
- 2 compartments, each with 1 clothes rail 3 sliding steel coat hooks 1 coupling holder for fire brigade belt (mounted on the left)

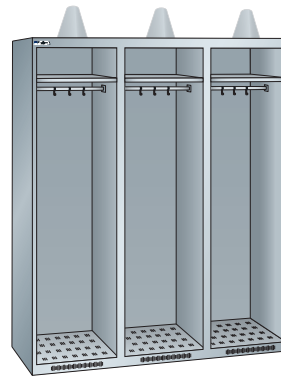

- 3 x 500 mm
- 3 storage compartments, open/lockable H 150 mm
- 3 compartments, each with 1 clothes rail 3 sliding steel coat hooks 1 coupling holder for fire brigade belt (mounted on the left)

**Cabinets**

**Compartment: W 500 mm**

Mounted helmet holders (not included in the price)



W  mm	Number of compartments	Compartment width mm	Storage compartment, open		Storage compartment, lockable with cylinder lock		
			Art. no.		Hinge pins mounted	Art. no.	
500	1	500	96.457.240		Pintle	96.403.240	
1000	2	500	96.458.240		Pintle	96.404.240	
1500	3	500	96.459.240		Pintle	96.405.240	

**D** **500 mm** **H** **1950 mm** Housing with internal helmet compartments

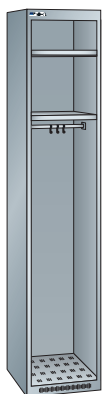

- 1 x 400 mm
- 1 storage compartment, open/lockable H 150 mm
- 1 helmet compartment, open, H 310 mm. Option of fastening helmet shelf (not included)
- 1 compartment, with 1 clothes rail 3 sliding steel coat hooks 1 coupling holder for fire brigade belt (mounted on the left)

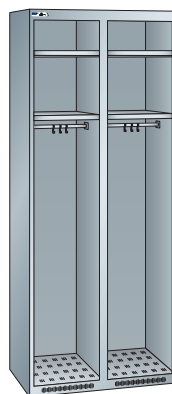

- 2 x 400 mm
- 2 storage compartments, open/lockable H 150 mm
- 2 helmet compartments, open, H 310 mm. Option of fastening helmet shelf (not included)
- 2 compartments, each with 1 clothes rail 3 sliding steel coat hooks 1 coupling holder for fire brigade belt (mounted on the left)



- 3 x 400 mm
- 3 storage compartments, open/lockable H 150 mm
- 3 helmet compartments, open, H 310 mm. Option of fastening helmet shelf (not included)
- 3 compartments, each with 1 clothes rail 3 sliding steel coat hooks 1 coupling holder for fire brigade belt (mounted on the left)

**Cabinets**

**Compartment: W 400 mm**

Internal helmet compartments



W  mm	Number of compartments	Compartment width mm	Storage compartment, open		Storage compartment, lockable with cylinder lock		
			Art. no.		Hinge pins mounted	Art. no.	
400	1	400	96.460.240		Pintle	96.418.240	
800	2	400	96.461.240		Pintle	96.419.240	
1200	3	400	96.462.240		Pintle	96.420.240	



# Fire-fighter lockers

## Pre-configured cabinets

Shelves open or with solid sheet compartment doors

### D 600 mm Housing with internal helmet compartments

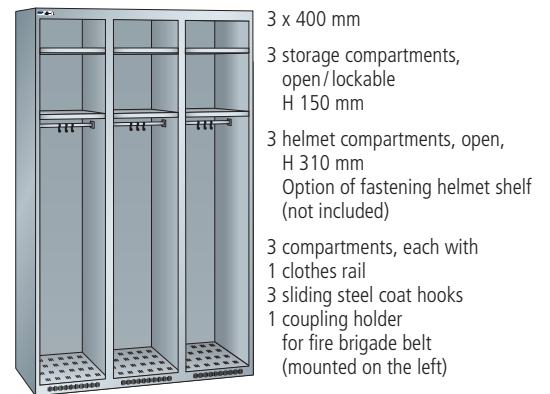
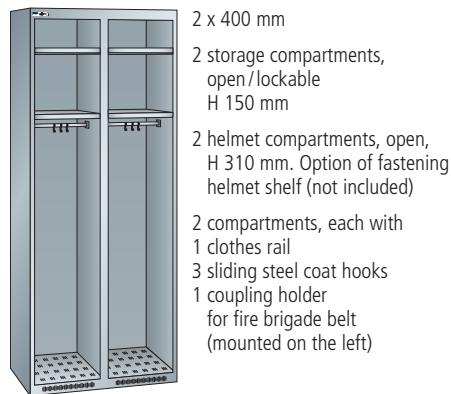
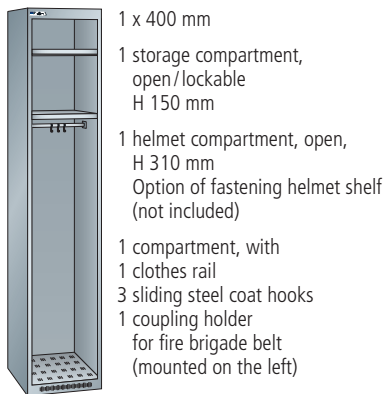

### Cabinets Compartment: W 400 mm Internal helmet compartments



W → mm	Number of compartments	compartment width mm	Storage compartment, open		Storage compartment, lockable with cylinder lock	
			Art. no.		Hinge pins mounted	Art. no.
400	1	400	96.466.240		Pintle	96.436.240
800	2	400	96.467.240		Pintle	96.437.240
1200	3	400	96.468.240		Pintle	96.438.240

### i Tip



#### Fast drying boots

Boots dry better on gratings with galvanised specification (see page 779).



Art. no. **96.438.240**  
Flame red, RAL 3000

**H ↑ 1950 mm**

**D ↗ 500 mm** Housing with internal helmet compartments

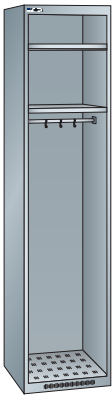

1 x 500 mm

- 1 storage compartment, open/lockable H 150 mm
- 1 helmet compartment, open, H 310 mm  
Option of fastening helmet shelf (not included)
- 1 compartment, with 1 clothes rail
- 3 sliding steel coat hooks
- 1 coupling holder for fire brigade belt (mounted on the left)

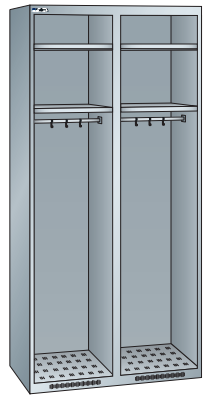

2 x 500 mm

- 2 storage compartments, open/lockable H 150 mm
- 2 helmet compartments, open, H 310 mm  
Option of fastening helmet shelf (not included)
- 2 compartments, each with 1 clothes rail
- 3 sliding steel coat hooks
- 1 coupling holder for fire brigade belt (mounted on the left)



3 x 500 mm

- 3 storage compartments, open/lockable H 150 mm
- 3 helmet compartments, open, H 310 mm  
Option of fastening helmet shelf (not included)
- 3 compartments, each with 1 clothes rail
- 3 sliding steel coat hooks
- 1 coupling holder for fire brigade belt (mounted on the left)

**Cabinets**  
**Compartment: W 500 mm**  
Internal helmet compartments



W → mm	Number of compartments	Compartment width mm	Storage compartment, open		Storage compartment, lockable with cylinder lock	
			Art. no.		Hinge pins mounted	Art. no.
500	1	500	<b>96.463.240</b>		Pintle	<b>96.421.240</b>
1000	2	500	<b>96.464.240</b>		Pintle	<b>96.422.240</b>
1500	3	500	<b>96.465.240</b>		Pintle	<b>96.423.240</b>

**D ↗ 600 mm** Housing with internal helmet compartments

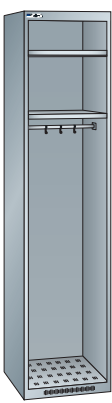

1 x 500 mm

- 1 storage compartment, open/lockable H 150 mm
- 1 helmet compartment, open, H 310 mm  
Option of fastening helmet shelf (not included)
- 1 compartment, with 1 clothes rail
- 3 sliding steel coat hooks
- 1 coupling holder for fire brigade belt (mounted on the left)

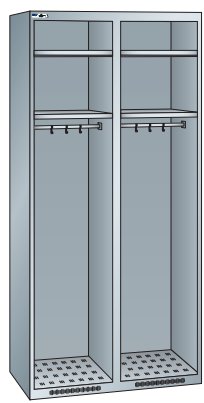

2 x 500 mm

- 2 storage compartments, open/lockable H 150 mm
- 2 helmet compartments, open, H 310 mm  
Option of fastening helmet shelf (not included)
- 2 compartments, each with 1 clothes rail
- 3 sliding steel coat hooks
- 1 coupling holder for fire brigade belt (mounted on the left)



3 x 500 mm

- 3 storage compartments, open/lockable H 150 mm
- 3 helmet compartments, open, H 310 mm  
Option of fastening helmet shelf (not included)
- 3 compartments, each with 1 clothes rail
- 3 sliding steel coat hooks
- 1 coupling holder for fire brigade belt (mounted on the left)

**Cabinets**  
**Compartment: W 500 mm**  
Internal helmet compartments



W → mm	Number of compartments	Compartment width mm	Storage compartment, open		Storage compartment, lockable with cylinder lock	
			Art. no.		Hinge pins mounted	Art. no.
500	1	500	<b>96.469.240</b>		Pintle	<b>96.439.240</b>
1000	2	500	<b>96.470.240</b>		Pintle	<b>96.440.240</b>
1500	3	500	<b>96.471.240</b>		Pintle	<b>96.441.240</b>

## Compartment doors for storage compartments with Key Lock / combination lock



### Compartment doors for shelves

The solid sheet doors are folded from one piece, flush-fitting and mounted on the right. The front of storage compartment is flush with the door. The door can be optionally equipped with a deposit slot for personal valuables. The slot allows fast storage of valuables without opening the compartment doors. The doors are mounted on internal hinge pins in plastic. The opening angle is approx. 110°. The compartment doors are prepared for installation in the top storage compartments and are available in the standard paint finish flame red, RAL 3000, as well as with a recess for Key Lock or a combination lock.

**Note:** simultaneously locking and further locking systems on request.

➤ For locking systems see page 118/119



Laminar cylinder lock



Locking mechanism



Combination lock

<b>W</b> ➔	Compartment doors for compartment width <b>mm</b>		
	Compartment door height 150 mm	Specification	Hinge pins mounted

### **Compartment door for storage compartment / Key Lock** (separately locking, collective locking system)

1 door / storage compartment, <b>excluding</b> lock	Solid sheet	Pintle	
---	-------------	--------	--

### **Compartment door for storage compartment / combination lock**

1 door / storage compartment <b>excluding</b> lock	Solid sheet	Pintle	
--	-------------	--------	--

<b>W</b> ➔	Compartment doors for compartment width <b>mm</b>		
	Compartment door height 150 mm	Specification	Hinge pins mounted

### **Compartment door with deposit slot for storage compartment / Key Lock** (separately locking, collective locking system)

1 door / storage compartment, <b>excluding</b> lock	Solid sheet	Pintle	
---	-------------	--------	--

### **Compartment door with deposit slot for storage compartment / combination lock**

1 door / storage compartment, <b>excluding</b> lock	Solid sheet	Pintle	
---	-------------	--------	--

### Locking systems

#### Separately lockable

Designation	Art. no.	
Laminar cylinder lock with 2 keys	<b>11.097.000</b>	
Locking mechanism single-bar / on right, without padlock	<b>11.033.000</b>	

#### Collective locking system

Each cabinet is fitted with a unique lock, requiring a unique key. However a collective key will open all the locks in the collective locking system.

Designation	Art. no.	
Cylinder lock for collective locking system, lock HS 10685 TE, including 2 keys	<b>11.099.000</b>	
Collective key	<b>11.051.000</b>	

#### Combination lock

The lock is supplied with a pre-set number combination which can be individually set. The combination can be changed at any time. Fastening material included.

Door stop	Width mm	Height mm	Art. no.	
Right	61	26	<b>94.882.000</b>	



Compartment door for **400 mm wide** storage compartment



Compartment door for **500 mm wide** storage compartment

**400**

**500**

Art. no.

Art. no.

96.472.240

96.473.240

96.373.240

96.374.240



Compartment door with deposit slot for **400 mm wide** storage compartment



Compartment door with deposit slot for **500 mm wide** storage compartment

**400**

**500**

Art. no.

Art. no.

96.367.240

96.368.240

96.370.240

96.371.240



**Colours**

Housing in standard paint finish: flame red, RAL 3000.  
12 more standard colours available on request.

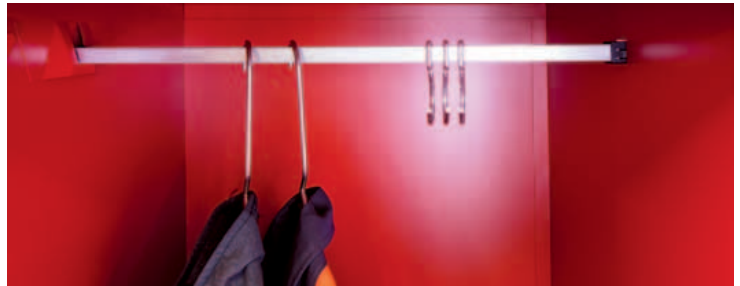

Cabinet systems





# Fire-fighter lockers

## Cabinet accessories

### Base and separate components



#### Base single-sided (for 1 cabinet)

Welded steel construction with angle profiles and adjustable plastic legs for levelling.  
Colour: anthracite grey, RAL 7016.

For housing width mm	For housing depth mm	Base height mm	Specification	Art. no.	
400	500	150	Single-sided	94.251.000	
500	500	150	Single-sided	96.477.000	
800	500	150	Single-sided	94.253.000	
1000	500	150	Single-sided	96.478.000	
1200	500	150	Single-sided	94.255.000	
1500	500	150	Single-sided	96.479.000	
400	600	150	Single-sided	96.480.000	
500	600	150	Single-sided	96.481.000	
800	600	150	Single-sided	96.482.000	
1000	600	150	Single-sided	96.483.000	
1200	600	150	Single-sided	96.484.000	
1500	600	150	Single-sided	96.485.000	

#### Base double-sided (for 2 cabinets, back-to-back)

Welded steel construction with angle profiles and adjustable plastic legs for levelling.  
Colour: anthracite grey, RAL 7016.



For housing width mm	For housing depth mm	Base height mm	Specification	Art. no.	
400	500	150	Double-sided	94.263.000	
500	500	150	Double-sided	96.486.000	
800	500	150	Double-sided	94.265.000	
1000	500	150	Double-sided	96.487.000	
1200	500	150	Double-sided	94.267.000	
1500	500	150	Double-sided	96.488.000	
400	600	150	Double-sided	96.489.000	
500	600	150	Double-sided	96.490.000	
800	600	150	Double-sided	96.491.000	
1000	600	150	Double-sided	96.492.000	
1200	600	150	Double-sided	96.493.000	
1500	600	150	Double-sided	96.494.000	





### Fastening brackets for wall assembly

The brackets are used to support the cabinet housing and are fastened to the wall with dowels, fastening material included. Specification: sheet steel bracket. Colour: anthracite grey, RAL 7016.

Number of compartments	Width mm	Art. no.	
1 x 400 mm	<b>400</b>	<b>94.275.000</b>	
1 x 500 mm	<b>500</b>	<b>96.495.000</b>	
2 x 400 mm	<b>800</b>	<b>94.277.000</b>	
2 x 500 mm	<b>1000</b>	<b>96.496.000</b>	
3 x 400 mm	<b>1200</b>	<b>94.279.000</b>	
3 x 500 mm	<b>1500</b>	<b>96.497.000</b>	

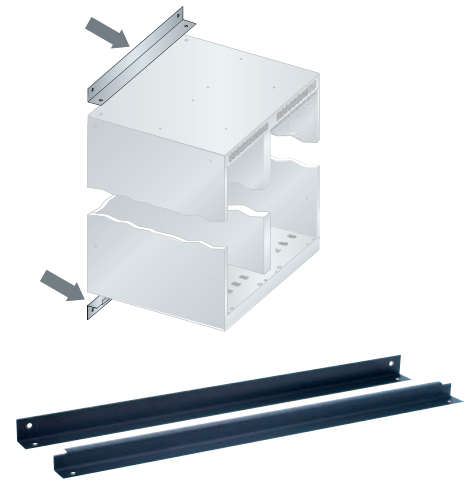

### Helmet holder (mounted on housing cover)

Special hat shape, including 3 fastening holes, fastening material included. The closed shape prevents straps and neck guard from snagging. Specification: polyethylene. Colour: black.

Ø mm	Height mm	Art. no.	
205 / 120	230	<b>11.378.000</b>	



### Helmet shelf (for internal helmet compartment)

Helmet is positioned automatically, does not need to be lifted when removed, including 3 fastening holes, fastening material included. Specification: plastic. Colour: black.

Width mm	Depth mm	Art. no.	
322	280	<b>96.498.000</b>	



### Grating for boots

Spot-welded grating with wire border. Specification: galvanised.

For compartment size (B x T) mm	Grating size mm	Meshing mm	Wire Ø mm	Art. no.	
<b>400 x 500</b>	395 x 440	50 x 60	3	<b>11.380.000</b>	
<b>500 x 500</b>	495 x 440	50 x 60	3	<b>96.474.000</b>	
<b>400 x 600</b>	395 x 540	50 x 60	3	<b>96.475.000</b>	
<b>500 x 600</b>	495 x 540	50 x 60	3	<b>96.476.000</b>	

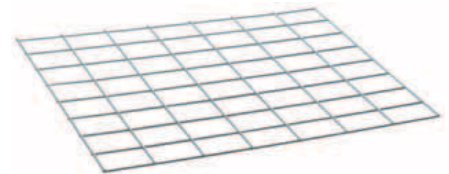

### Name plate

Self-adhesive name plate including white, replaceable paper for individual labelling. Specification: plastic.

Specification	Width mm	Height mm	Art. no.	
plastic	60	23	<b>10.754.000</b>	



### Number plate

Self-adhesive number plate with black engraved inlaid numbers. Specification: Astralon (plastic).

Specification	Width mm	Height mm	Art. no.	
Astralon	40	20	<b>11.499.000</b>	

